

THE NEW GENERATION!



⇒ COMPRESSED AIR FILTERS AND WATER SEPARATORS

INTELLIGENT AIR TECHNOLOGY

CompAir compressed air filters are designed to provide the most energy efficient filtration solutions available.

Low operating pressure drops mean that your compressor can operate at a lower working pressure than would be required with other filters. Lower working pressures result in reduced energy consumption. For example, a 2% reduction in working pressure results in a 1% saving in compressor energy costs.



Alocrom & dry power epoxy coated filter housing for full corrosion protection.

### ➔ NEW FILTRATION TECHNOLOGY

CF\_N compressed air filters use very little energy as they have a low resistance to air flow. Advancements such as deep bed pleating, graded density media and an oleophobic coating have led to a high performance filter element with low initial energy costs. Differential pressure starts low and stays low throughout its life. Service life is no longer dependent upon differential pressure, but on annual filter element change backed up with a one year air quality guarantee.

**AEROSPACE TURNING VANES**  
Turning vanes effectively direct air flow into the filter element.



**AIR STABILISERS**  
Smooth outlet air flow.

**SPECIAL FILTER MEDIA**  
Oleophobic nanofibre filter media actively repels oil and water to reduce pressure drop and keep running costs to a minimum. Filter media actively repels oil and water.



**HIGH EFFICIENCY DRAINAGE LAYER**  
Ensures coalesced liquids are removed quickly and efficiently.



**DRAINAGE RIBS**  
Filter housing and element integrate to provide capillary action which greatly improves liquid drainage. Interaction between housing and element also ensures maximum coalescing performance is achieved at all times.

**NO WET BAND FORMATION**  
Allows 40% more air flow through a smaller filter element.

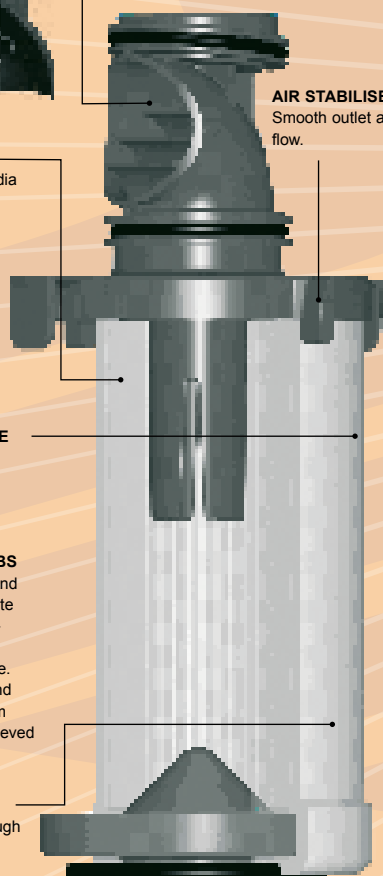

Filter Pressure Loss

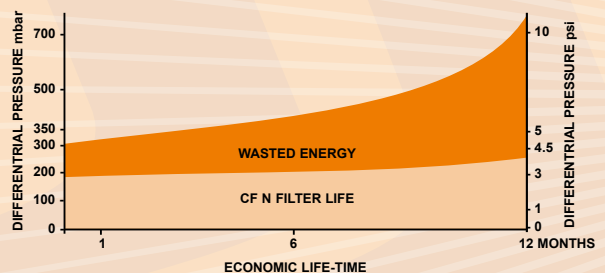

Compressed Air Quality & Product Selection  
Compressed Air Quality to ISO 8573.1

| CLASS | Solid Particle<br>Maximum number of particles per m <sup>3</sup> |                   |                   | Water<br>Pressure Dewpoint °C | Oil<br>(incl. Vapour)<br>mg/m <sup>3</sup> |
|-------|--|-------------------|-------------------|-------------------------------|--|
|       | 0.1–0.5<br>micron  | 0.5–1.0<br>micron | 1.0–5.0<br>micron |                               |  |
| 1     | 100  | 1                 | 0                 | -70                           | 0.01                                       |
| 2     | 100,000  | 1,000             | 10                | -40                           | 0.10                                       |
| 3     | –  | 10,000            | 500               | -20                           | 1.00                                       |
| 4     | –  | –                 | 1,000             | +3                            | 5.00                                       |
| 5     | –  | –                 | 20,000            | +7                            | –  |
| 6     | –  | –                 | –                 | +10                           | –  |

## ⇒ 5 FILTER VARIANTS AVAILABLE

To meet varying requirements, CompAir filters are available in five filter variants:

### TYPE B: HIGH EFFICIENCY GENERAL PURPOSE PROTECTION

Particle removal down to 1 micron, including water and oil aerosols. Maximum remaining oil aerosol content: 0.6 mg/m<sup>3</sup> at 21 °C/0.5 ppm(w) at 70 °F.

### TYPE C: HIGH EFFICIENCY OIL REMOVAL FILTRATION

Particle removal down to 0.01 micron, including water and oil aerosols. Maximum remaining oil aerosol content: 0.01 mg/m<sup>3</sup> at 21 °C/0.01 ppm(w) at 70 °F.

### TYPE D: OIL VAPOUR & ODOUR REMOVAL

Maximum remaining oil vapour content: 0.003 mg/m<sup>3</sup> at 21 °C/0.003 ppm(w) at 70 °F.

### TYPE E: GENERAL PURPOSE DUST FILTRATION

Dry particle removal down to 1 micron.

### TYPE F: HIGH EFFICIENCY DUST FILTRATION

Dry particle removal down to 0.01 micron.

## ⇒ ADVANCED FILTER HOUSINGS



### COMPACT & LIGHTWEIGHT

Advanced housing and element design has also provided a smaller, more compact and lightweight filter which is quick, easy and clean to maintain.

### MINIMAL SERVICE CLEARANCE

Space saving design minimises service clearance and allows installation in confined spaces.



### “Clean Change” Filter Element

Element changes are now easy and do not require the user to touch the contaminated element during annual element change.



No corrosion with Alocrom treatment



Rapid corrosion of untreated Aluminium



### FILTER CONNECTIONS

More port sizes are available to match both pipe size and system flow rate giving additional customer choice.

### FULLY CORROSION PROTECTED

Alocrom & dry powder epoxy coated for full corrosion protection.

## ⇒ OPTIONS



### Incident monitor (optional)

Used to indicate premature high differential pressure. Indicator can be retrofitted to existing housings without depressuring the system.



### FIXING CLAMP

Joins two filters and is a wall mounting bracket in one.



Float drain



Electronic drain

### CHOICE OF DRAINS

Manual, float and electronic drain options available. Easy connection with standard fittings via 1/2" threaded drain port.

| FILTER TYPE                           | PORT SIZE | FLOW RATE <sup>1)</sup> |       | DIMENSIONS |            | WEIGHT     | ELEMENT TYPE     | REPLACEMENT ELEMENT KIT NO. FILTER GRADE |           |           | NUMBER OF ELEMENTS |
|---------------------------------------|-----------|-------------------------|-------|------------|------------|------------|------------------|--|-----------|-----------|--------------------|
|                                       |           | at 7 bar g / 100 psi g  |       | LENGTH     | HEIGHT     |            |                  | B+E                                      | C+F       | D         |                    |
|                                       |           | m <sup>3</sup> /min     | scfm  | mm/in      | mm/in      | kg/lb      |                  |  |           |           |                    |
| CF0006N 1/4" (+Grade)                 | 1/4"      | 0.6                     | 21    | 76/3.0     | 181.5/7.12 | 0.4/0.88   | CE0006N + Grade  | A51128374                                | A51128474 | A51128574 | 1                  |
| CF0006N 3/8" (+Grade)                 | 3/8"      |                         |       |            |            |            |                  |  |           |           |                    |
| CF0006N 1/2" (+Grade)                 | 1/2"      |                         |       |            |            |            |                  |  |           |           |                    |
| CF0012N 3/8" (+Grade)                 | 3/8"      | 1.2                     | 42    | 97.5/3.8   | 235/9.3    | 1/2.2      | CE0012N + Grade  | A51128874                                | A51128974 | A51129074 | 1                  |
| CF0012N 1/2" (+Grade)                 | 1/2"      |                         |       |            |            |            |                  |  |           |           |                    |
| CF0018N 1/2" (+Grade)                 | 1/2"      |                         |       |            |            |            |                  |  |           |           |                    |
| CF0018N 3/4" (+Grade)                 | 3/4"      | 1.8                     | 64    | 97.5/3.8   | 235/9.3    | 1/2.2      | CE0018N + Grade  | A51129374                                | A51129474 | A51129574 | 1                  |
| CF0006N 1" (+Grade)                   | 1"        |                         |       |            |            |            |                  |  |           |           |                    |
| CF0036N 3/4" (+Grade)                 | 3/4"      |                         |       |            |            |            |                  |  |           |           |                    |
| CF0036N 1" (+Grade)                   | 1"        | 3.6                     | 127   | 129/5.1    | 274.8/10.8 | 2.2/4.84   | CE0036N + Grade  | A51129874                                | A51129974 | A51130074 | 1                  |
| CF0066N 1" (+Grade)                   | 1"        |                         |       |            |            |            |                  |  |           |           |                    |
| CF0066N 1 1/4" (+Grade)               | 1 1/4"    |                         |       |            |            |            |                  |  |           |           |                    |
| CF0066N 1 1/2" (+Grade)               | 1 1/2"    | 6.6                     | 233   | 129/5.1    | 364.3/14.3 | 2.6/5.72   | CE0066N + Grade  | A51130374                                | A51130474 | A51130574 | 1                  |
| CF0096N 1 1/4" (+Grade)               | 1 1/4"    |                         |       |            |            |            |                  |  |           |           |                    |
| CF0096N 1 1/2" (+Grade)               | 1 1/2"    |                         |       |            |            |            |                  |  |           |           |                    |
| CF0096N 1 1/2" (+Grade)               | 1 1/2"    | 9.6                     | 339   | 170/6.7    | 432.5/17   | 4.5/9.9    | CE0096N + Grade  | A51130874                                | A51130974 | A51131074 | 1                  |
| CF0132N 1 1/2" (+Grade)               | 1 1/2"    |                         |       |            |            |            |                  |  |           |           |                    |
| CF0132N 2" (+Grade)                   | 2"        |                         |       |            |            |            |                  |  |           |           |                    |
| CF0198N 2" (+Grade)                   | 2"        | 13.2                    | 466   | 170/6.7    | 524.5/20.6 | 5.25/11.55 | CE0132N + Grade  | A51131374                                | A51131474 | A51131574 | 1                  |
| CF0258N 2 1/2" (+Grade)               | 2 1/2"    |                         |       |            |            |            |                  |  |           |           |                    |
| CF0258N 3" (+Grade)                   | 3"        |                         |       |            |            |            |                  |  |           |           |                    |
| CF0372N 2 1/2" (+Grade)               | 2 1/2"    | 37.2                    | 1314  | 204.8/8.1  | 832.1/32.8 | 12/26.4    | CE0372N + Grade  | A51132874                                | A51132974 | A51133074 | 1                  |
| CF0372N 3" (+Grade)                   | 3"        |                         |       |            |            |            |                  |  |           |           |                    |
| CF0600N 4" (+Grade)                   | 4"        | 60                      | 2119  | 204.8/8.1  | 832.1/32.8 | X          | CE0600N + GradeF | A51133374                                | A51133474 | A51133574 | 3                  |
| <b>FLANGED HOUSINGS <sup>2)</sup></b> |           |                         |       |            |            |            |                  |  |           |           |                    |
| CF0132N (+Grade)F                     | DN50      | 13.2                    | 466   | 304/12     | 800/31.5   | 32.5/72    | CE0132N + GradeF | A51133874                                | A51133974 | A51134074 | 1                  |
| CF0258N (+Grade)F                     | DN80      | 25.8                    | 911   | 370/4.6    | 980/38.6   | 60/132     | CE0258N + GradeF | A51134374                                | A51134474 | A51134574 | 1                  |
| CF0372N (+Grade)F                     | DN80      | 37.2                    | 1314  | 370/16.6   | 1220/48    | 70/154     | CE0372N + GradeF | A51134874                                | A51134974 | A51135074 | 1                  |
| CF0600N (+Grade)F                     | DN100     | 60                      | 2119  | 500/19.7   | 1325/52.2  | 150/330    | CE0600N + GradeF | A51133374                                | A51133474 | A51133574 | 3                  |
| CF0780N (+Grade)F                     | DN100     | 78                      | 2755  | 500/19.7   | 1325/52.2  | 150/330    |                  |  |           |           | 4                  |
| CF1170N (+Grade)F                     | DN150     | 117                     | 4132  | 580/22.8   | 1424/56.1  | 200/440    |                  |  |           |           | 6                  |
| CF1950N (+Grade)F                     | DN200     | 195                     | 6886  | 750/29.5   | 1687/66.4  | 400/880    |                  |  |           |           | 10                 |
| CF3120N (+Grade)F                     | DN250     | 312                     | 11018 | 862/33.9   | 1821/71.7  | 540/1188   |                  |  |           |           | 16                 |
| CF4680N (+Grade)F                     | DN300     | 468                     | 16527 | 1000/39.4  | 1910/75.2  | 700/1540   |                  |  |           |           | 24                 |

| CF_N FILTER GRADE | INITIAL DIFFERENTIAL PRESSURE |                | FILTRATION | PRESSURE MAX. | RECOMMENDED TEMPERATURE |
|-------------------|-------------------------------|----------------|------------|---------------|-------------------------|
|                   | dry mbar / psi                | wet mbar / psi |            |               |                         |
| B <sup>3)</sup>   | 70/1                          | 0.6            | wet        | 16/232        | 1.5-80/35-176           |
| C <sup>3)</sup>   | 100/1.5                       | 200/3          |            |               |                         |
| D <sup>3)</sup>   | 70/1                          | N/A            | dry        | 20/290        | 1.5-50/35-122           |
| E <sup>3)</sup>   | 70/1                          |                | dry        | 20/290        | 1.5-100/35-212          |
| F <sup>3)</sup>   | 100/1.5                       |                |            |               |                         |

<sup>1)</sup> For flowrates at other pressures, apply the correction factor shown:

| LINE PRESSURE | CORRECTION FACTOR |    |    |    |    |    |     |     |     |     |     |     |     |     |     |     |    |
|---------------|-------------------|----|----|----|----|----|-----|-----|-----|-----|-----|-----|-----|-----|-----|-----|----|
|               | bar g             | 1  | 2  | 3  | 4  | 5  | 6   | 7   | 8   | 9   | 10  | 11  | 12  | 13  | 14  | 15  | 16 |
| psi g         | 15                | 29 | 44 | 58 | 73 | 87 | 100 | 116 | 131 | 145 | 160 | 174 | 189 | 203 | 218 | 232 |    |

<sup>2)</sup> Fabricated housings flanged to BS 4504 PN16 and designed to CEN 286 Part 1 (1991). Other pressure vessel standards available.

<sup>3)</sup> supplied with float drain / optional electronic drain

<sup>4)</sup> supplied with manual drain

FILTER TYPE CF 0006N 1/4-0600N 4

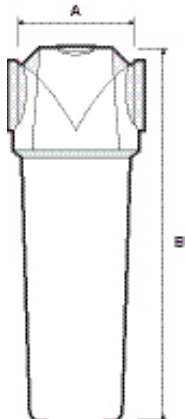

FILTER TYPE CF 0132-4680N

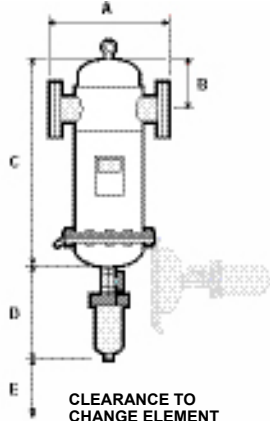

CLEARANCE TO CHANGE ELEMENT

FILTER TYPE CF 4N 1/4-51N 1/2 CD

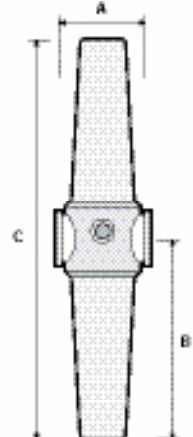

DATA ON DEMAND

## ➤ HIGH EFFICIENCY BULK LIQUID REMOVAL GRADE WS

WS Water Separators have been designed for the efficient removal of bulk liquid contamination from compressed air.

Today, many products are offered for the removal of bulk liquid WS Water Separators have been designed from the ground up with the key design focus concentrated in critical areas such as air flow management, separation efficiency at all flow conditions, minimal pressure losses and independently validated performance.

## ➤ BENEFITS

- Tested in accordance with ISO 8573.9
- Performance independently verified by Lloyds Register
- High liquid removal efficiencies at all flow conditions
- Low pressure losses for low operational costs
- Multiple port sizes for a given flow rate provides increased flexibility during installation
- Suitable for variable flow compressors
- Works with all types of compressor and compressor condensate
- Low maintenance
- 10 Year Housing Guarantee

## ➤ TYPICAL APPLICATIONS

- Bulk liquid removal at any point in a compressed air system
- Protection of refrigeration and adsorption dryer pre-filtration
- Liquid removal from compressor inter-coolers / after-coolers
- Liquid separation within refrigeration dryers

## ➤ SEPARATION EFFICIENCY

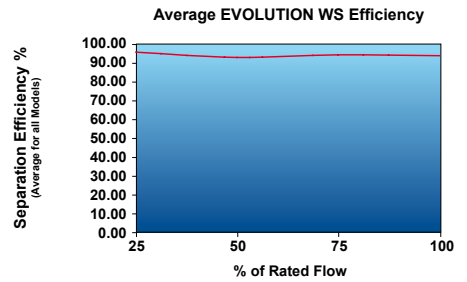

Tested with an Inlet challenge concentration of 33ml/m<sup>3</sup>hr and in accordance with ISO 85 Performance shown is an average for all models in range. Individual model performance available on request.



| SEPARATOR <sup>1)</sup> | PORT SIZE | FLOW RATES<br>m <sup>3</sup> /min |       |       |        |        | DIMENSIONS   |              | WEIGHT<br>net<br>kg |
|-------------------------|-----------|-----------------------------------|-------|-------|--------|--------|--------------|--------------|---------------------|
|                         |           | 5 bar                             | 7 bar | 9 bar | 10 bar | 13 bar | LENGTH<br>mm | HEIGHT<br>mm |                     |
| X006N 1/4"              | G"        | 0.45                              | 0.6   | 0.672 | 0.70   | 0.79   | 76           | 181.5        | 0.6                 |
| X006N 3/8"              | K"        |                                   |       |       |        |        |              |              |                     |
| X006N 1/2"              | H"        |                                   |       |       |        |        |              |              |                     |
| X024N 3/8"              | K"        | 1.8                               | 2.4   | 2.69  | 2.81   | 3.17   | 97.5         | 235          | 1.1                 |
| X024N 1/2"              | H"        |                                   |       |       |        |        |              |              |                     |
| X024N 3/4"              | I"        |                                   |       |       |        |        |              |              |                     |
| X024N 1"                | 1"        | 4.95                              | 6.6   | 7.39  | 7.72   | 8.71   | 129          | 275          | 2.2                 |
| X066N 3/4"              | I"        |                                   |       |       |        |        |              |              |                     |
| X066N 1"                | 1"        |                                   |       |       |        |        |              |              |                     |
| X066N 1 1/4"            | 1G"       | 15.75                             | 21    | 23.52 | 24.57  | 27.72  | 170          | 432.5        | 5.1                 |
| X210N 1 1/4"            | 1G"       |                                   |       |       |        |        |              |              |                     |
| X210N 1 1/2"            | 1H"       |                                   |       |       |        |        |              |              |                     |
| X210N 2"                | 2"        | 36.00                             | 48    | 53.76 | 56.16  | 63.36  | 205          | 505          | 10                  |
| X480N 2 1/2"            | 2H"       |                                   |       |       |        |        |              |              |                     |
| X480N 3"                | 3"        |                                   |       |       |        |        |              |              |                     |
| X480 F                  | DN80      | 40.8                              | 48    | 54.2  | 57.1   | 65.3   | 370          | 1199         | 105                 |
| X600 F                  | DN100     | 51.0                              | 60    | 67.8  | 71.4   | 81.6   | 450          | 1241         | 105                 |
| X1080 F                 | DN150     | 91.8                              | 108   | 122.0 | 128.5  | 146.9  | 580          | 1424         | 200                 |
| X1800 F                 | DN200     | 153.0                             | 180   | 203.4 | 214.2  | 244.8  | 750          | 1687         | 400                 |
| X2880 F                 | DN250     | 244.8                             | 288   | 325.4 | 342.7  | 391.7  | 862          | 1821         | 540                 |
| X4320 F                 | DN300     | 367.2                             | 432   | 488.2 | 514.1  | 587.5  | 1000         | 1910         | 700                 |

<sup>1)</sup> supplied with float drain / optional Zero loss drain

For pressures of 16 to 20 bar (g) an alternative drain must be used

CompAir policy is one of continuous improvement and we therefore reserve the right to alter specifications without prior notice.

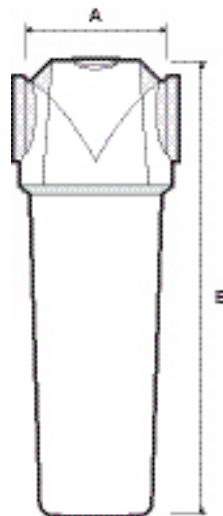

## INTELLIGENT AIR TECHNOLOGY



**INTERNET:**

[www.compair.com](http://www.compair.com)

[sales@compair.com](mailto:sales@compair.com)



CompAir Policy is one of continuous improvement and we therefore reserve the right to alter specification and prices without prior notice. All products are sold subject to the Company's conditions of sale.